

C2200 Tube Preamplifier



C2200

IMPORTANT SAFETY INSTRUCTIONS!

PLEASE READ THEM BEFORE OPERATING THIS EQUIPMENT.

The lightning flash with arrowhead, within an equilateral triangle, is intended to alert the user to the presence of uninsulated "dangerous voltage" within the product's enclosure that may be of sufficient magnitude to constitute a risk of electric shock to persons.



AVIS RISQUE DE CHOC ELECTRIQUE - NE PAS OUVRIR.

The exclamation point within an equilateral triangle is intended to alert the user to the presence of important operating and maintenance (servicing) instructions in the literature accompanying the appliance.

WARNING - TO REDUCE RISK OF FIRE OR ELECTRICAL SHOCK, DO NOT EXPOSE THIS EQUIPMENT TO RAIN OR MOISTURE.

NO USER-SERVICEABLE PARTS INSIDE. REFER SERVICING TO QUALIFIED PERSONNEL.

To prevent the risk of electric shock, do not remove cover or back. No user serviceable parts inside.

General:

1. Read these instructions.
2. Keep these instructions.
3. Heed all warnings.
4. Follow all instructions.
5. **Warning: To reduce risk of fire or electrical shock, do not expose this equipment to rain or moisture. This unit is capable of producing high sound pressure levels. Continued exposure to high sound pressure levels can cause permanent hearing impairment or loss. User caution is advised and ear protection is recommended when playing at high volumes.**
6. **Caution: to prevent electrical shock do not use this (polarized) plug with an extension cord, receptacle or other outlet unless the blades can be fully inserted to prevent blade exposure.**
Attention: pour prevenir les chocs electriques pas utiliser cette fiche polarisee avec un prolongateur, une prise de courant ou un autre sortie de courant, sauf si les lames peuvent etre inserees afond ans en laisser aucune partie a decouvert.
7. Unplug this equipment during lightning storms or when unused for long periods of time.
8. Only use attachments/accessories specified by the manufacturer.

Installation:

9. The equipment shall be installed near the AC Socket Outlet and the disconnect device shall be easily accessible.
10. Do not block any ventilation openings. Install in accordance with the manufacturer's instructions.
11. Do not install near any heat sources such as radiators, heat registers, stoves, or other equipment (including amplifiers) that produce heat.
12. Do not use this equipment near water.
13. Do not expose this equipment to dripping or splashing and ensure that no objects filled with liquids, such as vases, are placed on the equipment.
14. Use only with the cart, stand, tripod, bracket, or table specified by the manufacturer, or sold with the equipment. When a cart is used, use caution when moving the cart/equipment combination to avoid injury from tip-over.



Connection:

15. Connect this equipment only to the type of AC power source as marked on the unit.
16. Protect the power cord from being walked on or pinched particularly at plugs, convenience receptacles, and the point where they exit from the equipment.

-
17. Do not defeat the safety purpose of the polarized or grounding-type plug.
A polarized plug has two blades with one wider than the other. A grounding type plug has two blades and a third grounding prong. The wide blade or the third prong are provided for your safety. If the provided plug does not fit into your outlet, consult an electrician for replacement of the obsolete outlet.
 18. Do not overload wall outlets, extension cords or integral convenience receptacles as this can result in a risk of fire or electric shock.
 19. To completely disconnect this equipment from the AC Mains, disconnect the power supply cord plug from the AC receptacle.

Care of Equipment:

20. Clean only with a dry cloth.
21. Do not permit objects or liquids of any kind to be pushed, spilled and/or fall into the equipment through enclosure openings.
22. Unplug the power cord from the AC power outlet when left unused for a long period of time.

Repair of Equipment:

23. Refer all servicing to qualified service personnel. Servicing is required when the equipment has been damaged in any way, such as power-supply cord or plug is damaged, liquid has been spilled or objects have fallen into the equipment, the equipment has been exposed to rain or moisture, does not operate normally, or has been dropped.
24. Do not attempt to service beyond that described in the operating instructions. All other service should be referred to qualified service personnel.
25. When replacement parts are required, be sure the service technician has used replacement parts specified by McIntosh or have the same characteristics as the original part. Unauthorized substitutions may result in fire, electric shock, or other hazards.
26. Upon completion of any service or repairs to this product, ask the service technician to perform safety checks to determine that the product is in proper operating condition.

Thank You

Your decision to own this McIntosh C2200 Tube Preamplifier ranks you at the very top among discriminating music listeners. You now have "The Best." The McIntosh dedication to "Quality," is assurance that you will receive many years of musical enjoyment from this unit.

Please take a short time to read the information in this manual. We want you to be as familiar as possible with all the features and functions of your new McIntosh.

Please Take A Moment

The serial number, purchase date and McIntosh Dealer name are important to you for possible insurance claim or future service. The spaces below have been provided for you to record that information:

Serial Number: _____

Purchase Date: _____

Dealer Name: _____

Technical Assistance

If at any time you have questions about your McIntosh product, contact your McIntosh Dealer who is familiar with your McIntosh equipment and any other brands that may be part of your system. If you or your Dealer wish additional help concerning a suspected problem, you can receive technical assistance for all McIntosh products at:

McIntosh Laboratory, Inc.
2 Chambers Street
Binghamton, New York 13903
Phone: 607-723-1545
Fax: 607-723-3636

Customer Service

If it is determined that your McIntosh product is in need of repair, you can return it to your Dealer. You can also return it to the McIntosh Laboratory Service Department. For assistance on factory repair return procedure, contact the McIntosh Service Department at:

McIntosh Laboratory, Inc.
2 Chambers Street
Binghamton, New York 13903
Phone: 607-723-3515
Fax: 607-723-1917

McIntosh

Table of Contents

Safety Instructions	2
Thank You and Please Take a Moment	3
Technical Assistance and Customer Service	3
Table of Contents and General Notes	4
Connector Information	4
Introduction	5
Performance Features	5
Dimensions	6
Installation	7
Connections	
Rear Panel Connections	8
How to Connect for Power Control	9
How to Connect for Audio and Data Control	10
How to Connect for Pass Thru Mode	11
How to Connect for a Second Room	12
Front Panel Features	
Front Panel Controls, Displays, Push-buttons, and Switches	13
Setup	
How to Operate the Setup Mode	14
Default Settings	14
Display Brightness	14
Input Trim Level	15
Re-Title Inputs	15
Power Control Triggers	16
Auto Tone	16
Pass Thru Mode	17
Power On Option	17
Remote Control Selection	17
Firmware Version	18
Operation	
How to Operate the C2200	19
Remote Control Push-buttons	22
How to Operate by Remote Control	23
Additional Information	
Technical Description	24
Specifications	26
Packing Instruction	27

General Notes

1. The C2200 uses Vacuum Tubes for amplifying the audio signal. **The C2200 is designed to have only qualified Service Personnel perform any part(s) replacement including all the vacuum tubes.**
2. For additional information on Audio Connections, refer to the Owner's Manual(s) for the component(s).
3. Connecting Cables and Connectors are available from the McIntosh Parts Department:
Data and Power Control Cable Part No. 170-202
Six foot, shielded 2 conductor, with 1/8 inch stereo mini phone plug on each end.

4. The Main AC Power going to the C2200 and any other McIntosh Component(s) should not be applied until all the system components are connected together. When the C2200 and other McIntosh Components are in their Standby Power Off Mode, the Microprocessor's Circuitry inside each component is active and communication is occurring between them. Failure to do so could result in malfunctioning of some or all of the system's normal operations.
5. Up to four Sensors can be wired in parallel for Remote Control of the C2200 from other rooms.
6. Balanced and Unbalanced Inputs and Outputs can be mixed. For example, you may connect signal sources to Unbalanced Inputs and send signals from the Balanced Outputs. You can also use Balanced and Unbalanced Outputs simultaneously, connected to different Power Amplifiers.
7. A McIntosh Power Controller may be added to the C2200 to provide AC Power Switching to components that do not have Power Control Connections. See your McIntosh Dealer for additional information.
8. Sound Intensity is measured in units called Decibels and "dB" is the abbreviation.
9. The PHONO Circuitry uses four Vacuum Tubes. Those tubes are only Powered-On (glow coming from the tubes) when the AUX Input is re-titled to PHONO in the Setup Mode. Refer to page 15 "Re-Titled Inputs" for additional information.

Connector Information

XLR Connectors

Below is the Pin configuration for the XLR Balanced Input and Output Connectors on the C2200. Refer to the diagram for connection:

- PIN 1: Shield/Ground
- PIN 2: + Input
- PIN 3: - Input

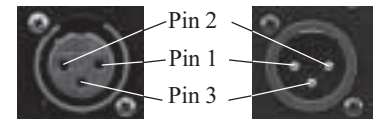

Power Control and Trigger Connectors

The C2200's Power Control Outputs provide a 5 volt signal. Use a 1/8 inch stereo mini phone plug to connect to the Power Control Input on other McIntosh Components.

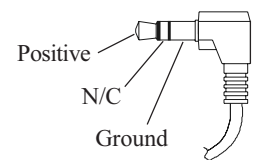

Data Port Connector

The C2200's Data Port Output provides Remote Control Signals. Use a 1/8 inch stereo mini phone plug to connect to the Data Port Inputs on McIntosh Source Units.

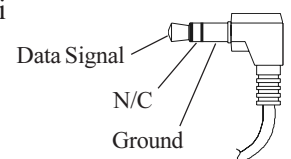

Introduction

The McIntosh C2200 Tube Preamplifier is without question the finest Audio Tube Preamplifier ever created. No design compromises were allowed in the quest for a Tube Preamplifier with absolute accuracy, total sonic purity and virtual elimination of distortion and audible noise. For those who have been searching for their “Last Tube Preamplifier”, your search is over.

Performance Features

- **Balanced Inputs and Outputs**

Four balanced high level Inputs and three balanced Outputs are provided.

- **Precision Tracking Volume Control**

Volume levels are controlled by a new Multi-Stage Precision Digitally Controlled Attenuator System with a tracking accuracy of 0.1dB. Levels change in 214 individual 0.5dB steps.

- **Variable Rate Volume and Balance Control Selection**

The C2200 Tube Preamplifier’s Volume and Balance Control Circuitry provides an ideal rate of change with control rotation.

- **Tone Control with Assignable Bypass**

The Bass and Treble Control Circuit Elements can be removed from the Signal Path of any selected input.

- **Alphanumeric Fluorescent Display**

The Multifunction Front Panel Display indicates the Source Selection, Volume and Balance Levels. Setup Mode Selections and Adjustments are also displayed. The display intensity is fully adjustable.

- **Electromagnetic Input Switching with Level Trim Adjustment and Title Reassignment**

Digital Logic integrated circuits drive Electromagnetic Switches on all Inputs and operating functions for reliable, noiseless, distortion free switching. All eight Inputs on the C2200 can be matched in level, so that there are no abrupt changes in volume levels between the different Inputs. There is also a Record Monitor function for checking the progress of a recording. Any of the eight Inputs can have their Input Title reassigned to match the sources in the system.

- **Precision Parts**

Only the finest precision 1% tolerance resistors are used throughout.

- **Low Distortion**

Distortion levels of all types are less than 0.08%. Music is amplified with total transparency and accuracy.

- **Moving Magnet Phono Input**

There is a Precision Phono Preamplifier for Moving Magnet Cartridges.

- **Multichannel Pass Thru Mode**

The Input Assignable, Automatic Pass Thru Mode allows the C2200 to become part of a Multichannel Sound System for DVD-Audio, SACD and Home Theater. The Left and Right Channels of the C2200 become the two front channels, simply by turning on the Multichannel Processor.

- **Remote Control**

The C2200 includes a Remote Control that allows remote operation of the Front Panel Controls and Push-buttons.

- **Optional External Sensor Input**

There are provisions for connecting External Sensors, which allows for enjoyment of your McIntosh System from other room(s) in your home via the Remote Control.

- **Output Switching**

Front panel Output Push-buttons control two Switched Outputs that allow sending signals to two separate Power Amplifiers.

- **Power Control Output and Trigger Assignment**

A Power Control connection for convenient Turn-On of McIntosh Power Amplifiers, Source Components and Accessories is included. Three of the Power Control Outputs may be assigned to activate when a given Input is selected.

Dimensions

The following dimensions can assist in determining the best location for your C2200. There is additional information on the next page pertaining to installing the C2200 into cabinets.

Front View of the C2200



Rear View of the C2200



Side View of the C2200

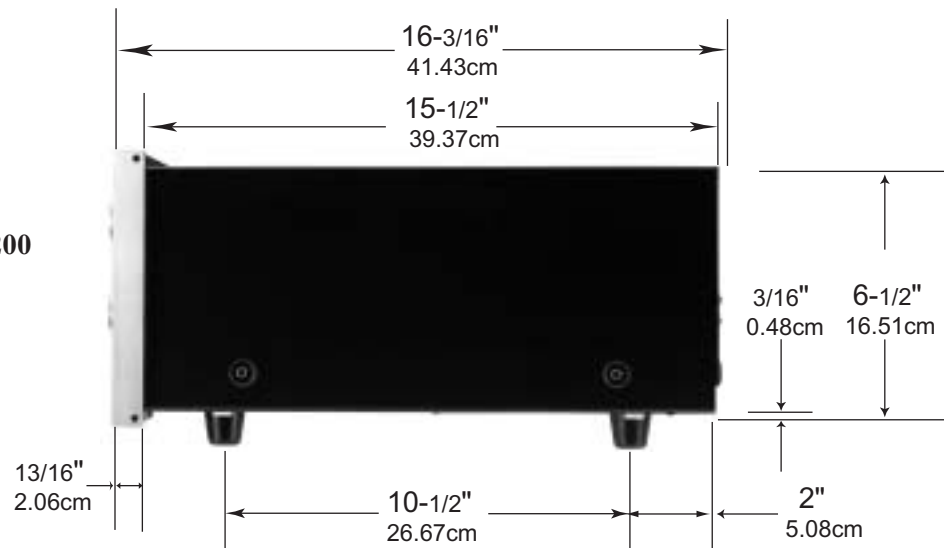

Installation

The C2200 can be placed upright on a table or shelf, standing on its four feet. It also can be custom installed in a piece of furniture or cabinet of your choice. The four feet may be removed from the bottom of the C2200 when it is custom installed as outlined below. The four feet together with the mounting screws should be retained for possible future use if the C2200 is removed from the custom installation and used free standing. The required panel cutout, ventilation cutout and unit dimensions are shown.

Always provide adequate ventilation for your C2200. Cool operation ensures the longest possible operating life for any electronic instrument. Do not install the C2200 directly above a heat generating component such as a high powered amplifier. If all the components are installed in a single cabinet, a quiet running ventilation fan can be a definite asset in maintaining all the system components at the coolest possible operating temperature.

A custom cabinet installation should provide the following minimum spacing dimensions for cool operation. Allow at least 2

inches (5.08cm) above the top, 2 inches (5.08cm) below the bottom and 1 inch (2.54cm) on each side of the A/V Control Center, so that airflow is not obstructed. Allow 19-1/2 inches (49.53cm) depth behind the front panel. Allow 1-1/8 inch (2.9cm) in front of the mounting panel for knob clearance. Be sure to cut out a ventilation hole in the mounting shelf according to the dimensions in the drawing.

C2200 Front Panel Custom Cabinet Cutout

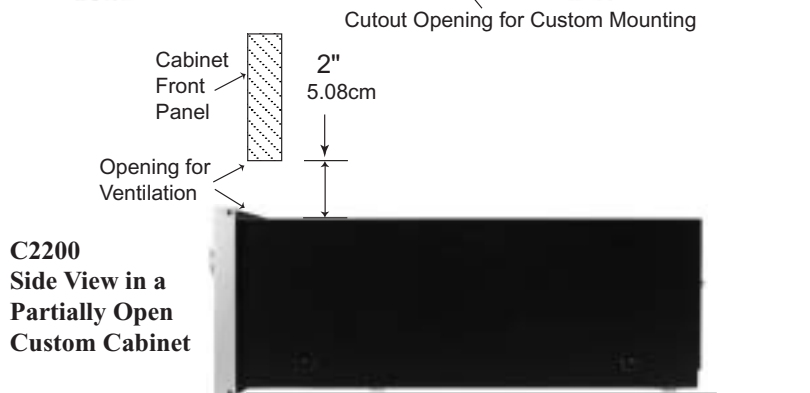
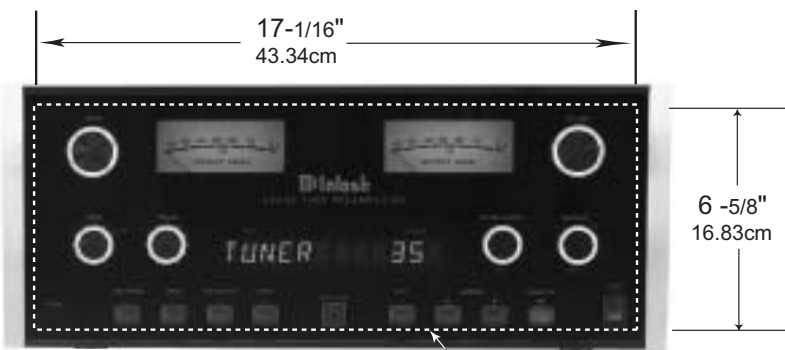

C2200 Support Shelf in Custom Cabinet

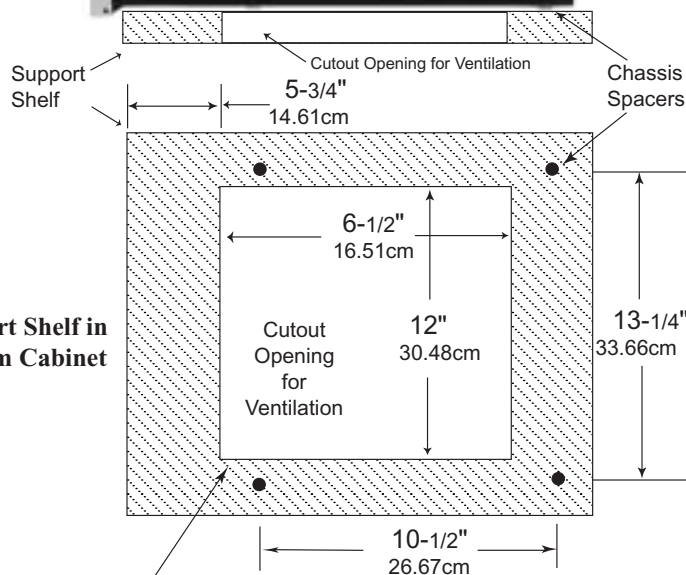

Notes: Center the Cutout Horizontally on unit. For purposes of clarity, the above illustration is not drawn to scale.

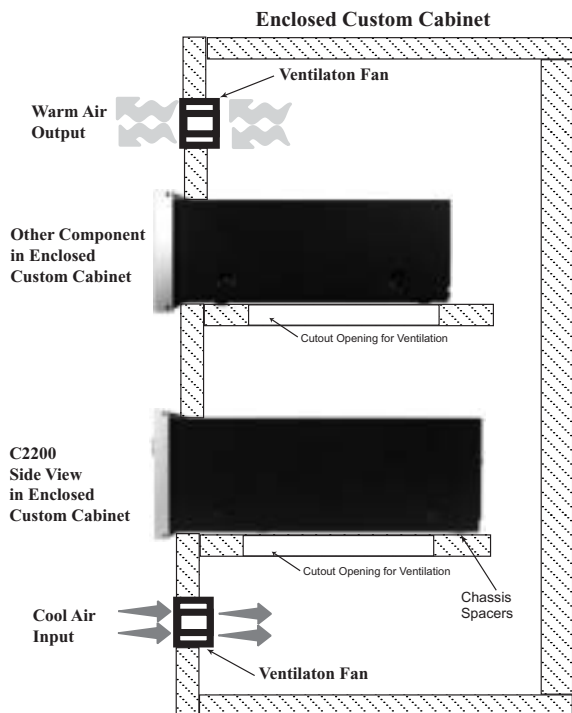

Unbalanced MAIN OUTPUTS contain the program signals at all times. The Unbalanced 1 and 2 OUTPUTS contain the program signals and turn On/Off with the Front Panel OUTPUTS 1 and 2 Push-buttons

Balanced MAIN OUTPUTS contain the program signals at all times. The Balanced 1 and 2 OUTPUTS and can be switched On/Off with the Front Panel OUTPUTS 1 and 2 Push-buttons

TAPE/REC OUTPUTS contain RECOrd Out Signals

TAPE/REC, VCR, SAT, DVD, CD, CD2 and TUNER unbalanced INPUTS accept high level program source signals

VCR, SAT, DVD and CD Balanced INPUTS accept high level program source signals

Ground connection for turntables

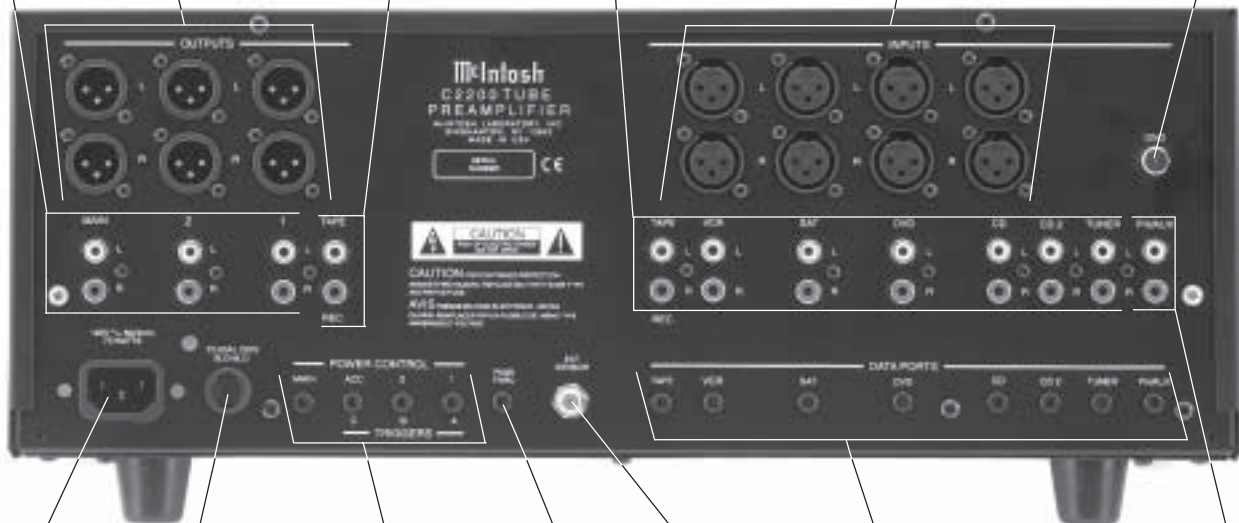

Connect the power cord to a live AC outlet. Refer to information on the back panel of the C2200 to determine the correct voltage

POWER CONTROL/TRIGGERS Outputs send Turn-On signals to other components connected to the C2200. The MAIN Jack sends the signal when the C2200 is switched On. The 1 and 2 Jacks send the signal when the OUTPUTS 1 and 2 Push-buttons are active. The ACCESSORY Jack is for sending the signal to McIntosh Source Components. The SETUP Feature in the C2200 allows the ACC, 1 and 2 Power Control Jacks to be re-assigned to Switch On when the desired Input Source is selected.

Main Fuse holder, refer to information on the back panel of the C2200 to determine the correct fuse size and rating

The EXTERNAL SENSOR Jack permits the connection of a McIntosh IR Sensor for remote operation

PASS THRU Power Control input receives a Turn-On signal from a McIntosh Home Theater Controller

PH/AUX accepts high level program source signals or signals from a Moving Magnet Phono Cartridge. The SETUP feature determines whether the Input Jacks are set for AUX or PHONO

DATA PORTS send control signals to compatible source components and allow Remote Control operation

How to Connect for Power Control

The four Power Control Jacks have default settings as explained on page 8. The hookup example below utilizing the default settings. If you wish to use any one of the three assignable Power Control Outputs as a dedicated Trigger instead, connect that Component Source Unit's Power Control Input to the desired Trigger Output (A, B, or C). The default setting in the C2200 Setup needs to be changed to match the new Power Control Connection.

1. Connect a Control Cable from the C2200 POWER CONTROL ACCESSory Jack to the Power Control In

2. Connect a Control Cable from the McIntosh CD Player Power Control Out Jack to the Power Control In Jack on the McIntosh Tuner.
3. Connect a Control Cable from the McIntosh Tuner Power Control Out Jack to the Power Control Jack on the McIntosh Power Control.
4. Connect a Control Cable from the C2200 MAIN POWER CONTROL Jack to the Power Control In Jack on the McIntosh Power Amplifier.

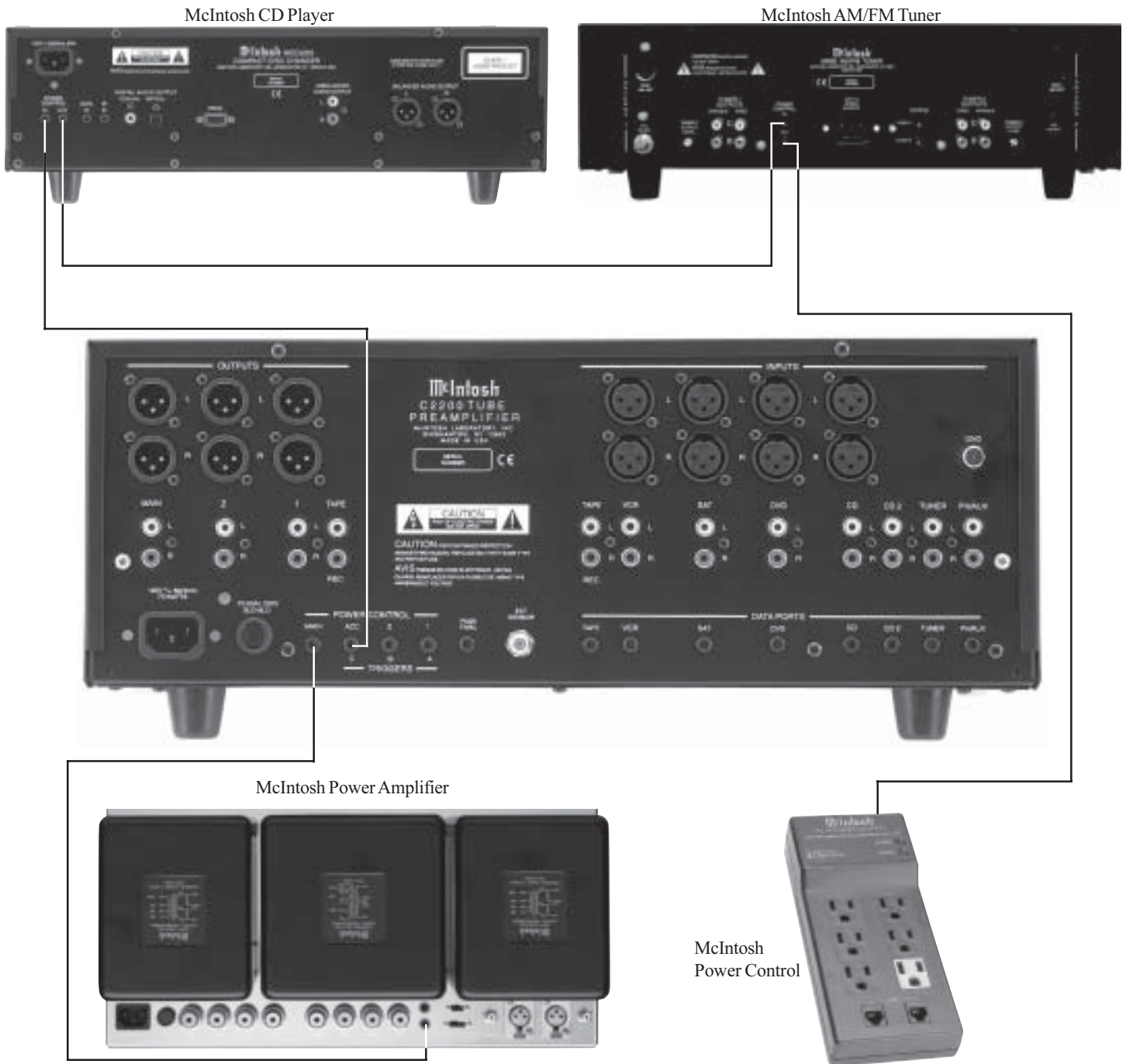

How to Connect for Audio and Data Control

1. Connect Audio Cables from the McIntosh C2200 MAIN Balanced OUTPUTS to the McIntosh Power Amplifier Balanced INPUTS.

Note: The unbalanced MAIN Audio Outputs and unbalanced Power Amplifier Inputs may be used instead of the Balanced Connections.

2. Connect Audio Cables from the McIntosh CD Player Balanced Audio Outputs to the C2200 CD Balanced INPUTS.

Note: The unbalanced Audio Outputs and Inputs may be used instead of the Balanced Connections.

3. Connect an Audio Cable from a McIntosh Tuner 1 Outputs to the C2200 TUNER INPUTS.

4. Connect an Audio Cable from a Turntable to the PH/AUX INPUTS and the Turntable Ground Connection to the GND grounding post.

5. Connect an Audio Cable from the C2200 TAPE/REC OUTPUTS to the Record Inputs of a Tape Recorder and from the C2200 TAPE INPUTS to a Tape Recorder Outputs.

6. Connect a Control Cable from the C2200 CD DATA PORT Jack to the DATA IN Jack on the McIntosh CD Player.

7. Connect a Control Cable from the C2200 TUNER DATA PORT Jack to the DATA IN Jack on the McIntosh Tuner.

Note: By adding a McIntosh Remote Control Translator to the C2200, non McIntosh Source Devices such as a Satellite Receiver can be remotely controlled using a McIntosh Remote Control and Keypad/Sensor.

8. Connect the C2200 Power Cord to a live AC outlet.

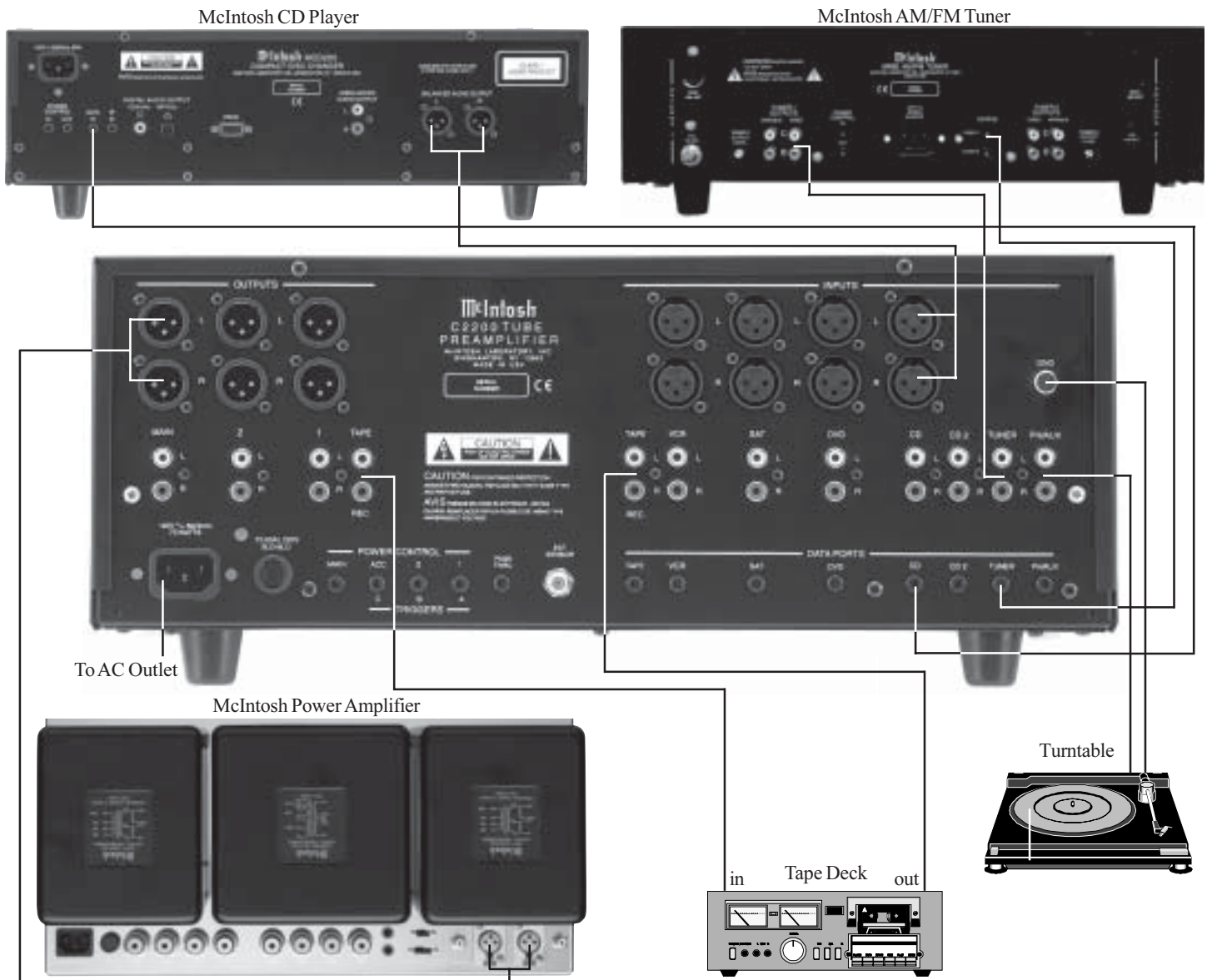

How to Connect for Pass Thru Mode

The PASS THRU Mode on the C2200 allows it to be part of a Multichannel System for the Left and Right Front Channels, when it is connected to a McIntosh Multichannel Processor such as the MX134.

Any of the C2200's High Level Inputs may be used for the PASS THRU Function. The C2200 default setting for the PASS THRU feature needs to be changed in Setup. Connect the basic system as outlined in the two previous pages and then add the two following connections. The example below uses the AUX Input for the PASS THRU Mode.

1. Connect a Power Control Cable from the McIntosh A/V Controller Power Control Zone A to the C2200 PASS THRU Jack.
2. Connect an Audio Cable from the McIntosh A/V Controller Zone A Front Left and Right Audio Outputs to the C2200 AUX 1 INPUTS.

McIntosh A/V Control Center

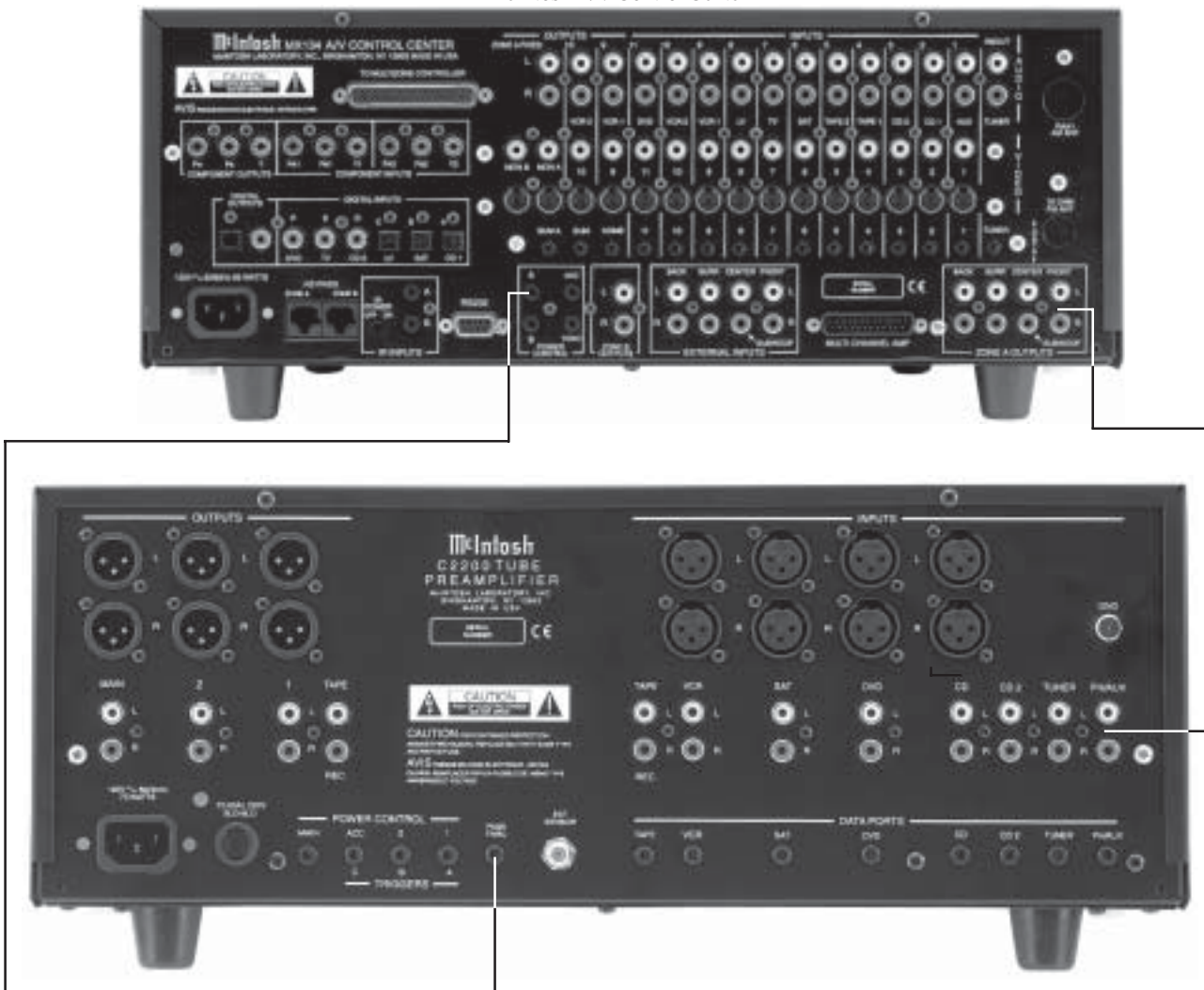

How to Connect for a Second Room

1. Connect Audio Cables from the C2200 Balanced OUTPUTS 2 to the Second Power Amplifier Balanced Inputs.

Notes: The unbalanced Audio OUTPUTS 2 and unbalanced Power Amplifier Inputs may be used instead of the Balanced Connections. When a second room is connected, it is sometimes desirable to switch Off the Loudspeakers in the Main Listening Room. This can be accomplished by connecting the Main Power Amplifier to the C2200 OUTPUTS 1 instead of the MAIN OUTPUTS, so that they can be switched Off by the Front Panel OUTPUTS 1 Push-button.

2. Connect a Control Cable from the C2200 POWER CONTROL 2 Jack to the Power Control In of a McIntosh Power Amplifier.

3. Connect an RG6 or RG59U coaxial cable from the EXTERNAL SENSOR Jack to a Keypad.

Note: A Wall Mounted IR Sensor may also be used in place of the Keypad.

Keypad

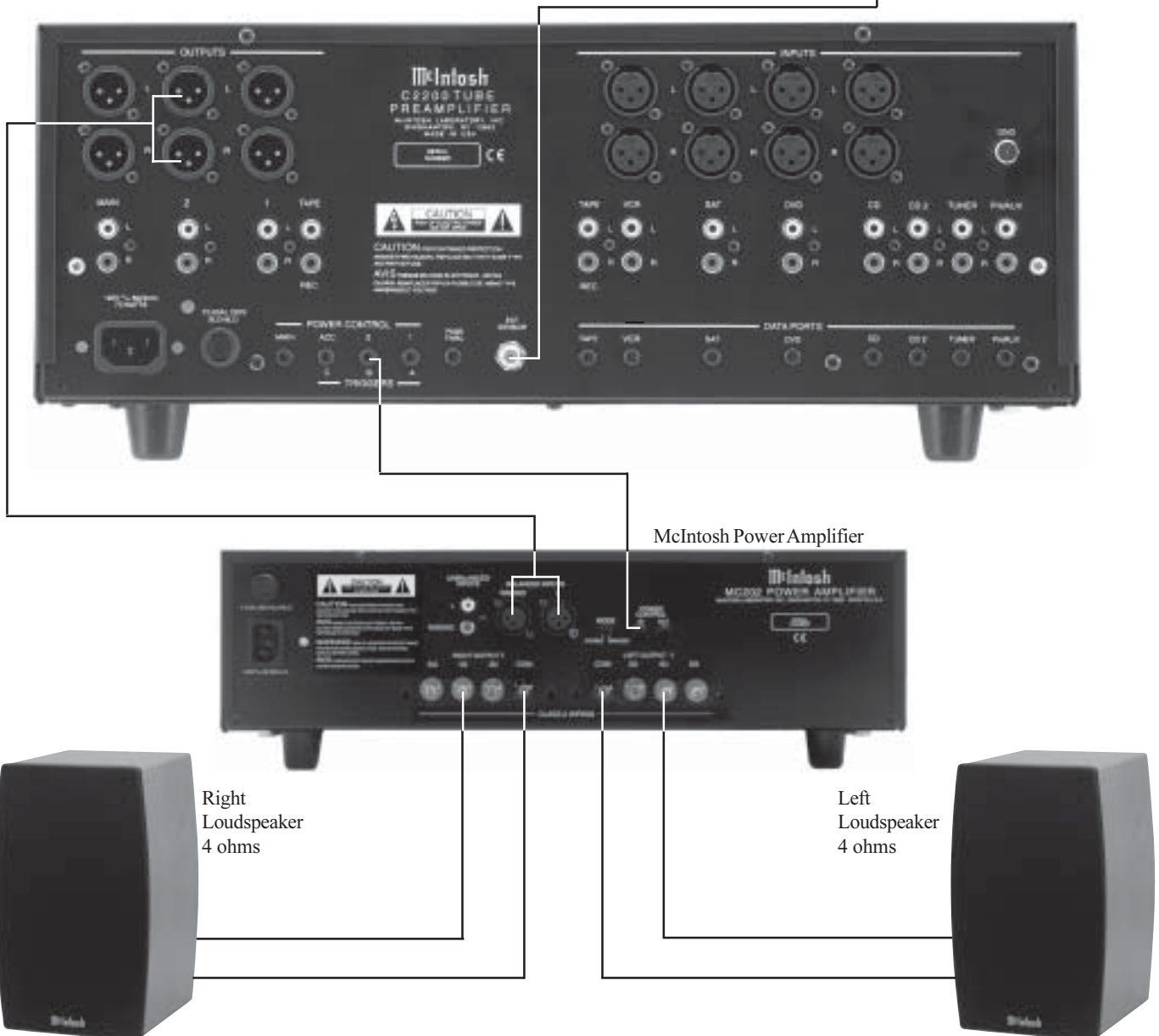

Front Panel Controls, Displays, Push-Buttons, and Switches

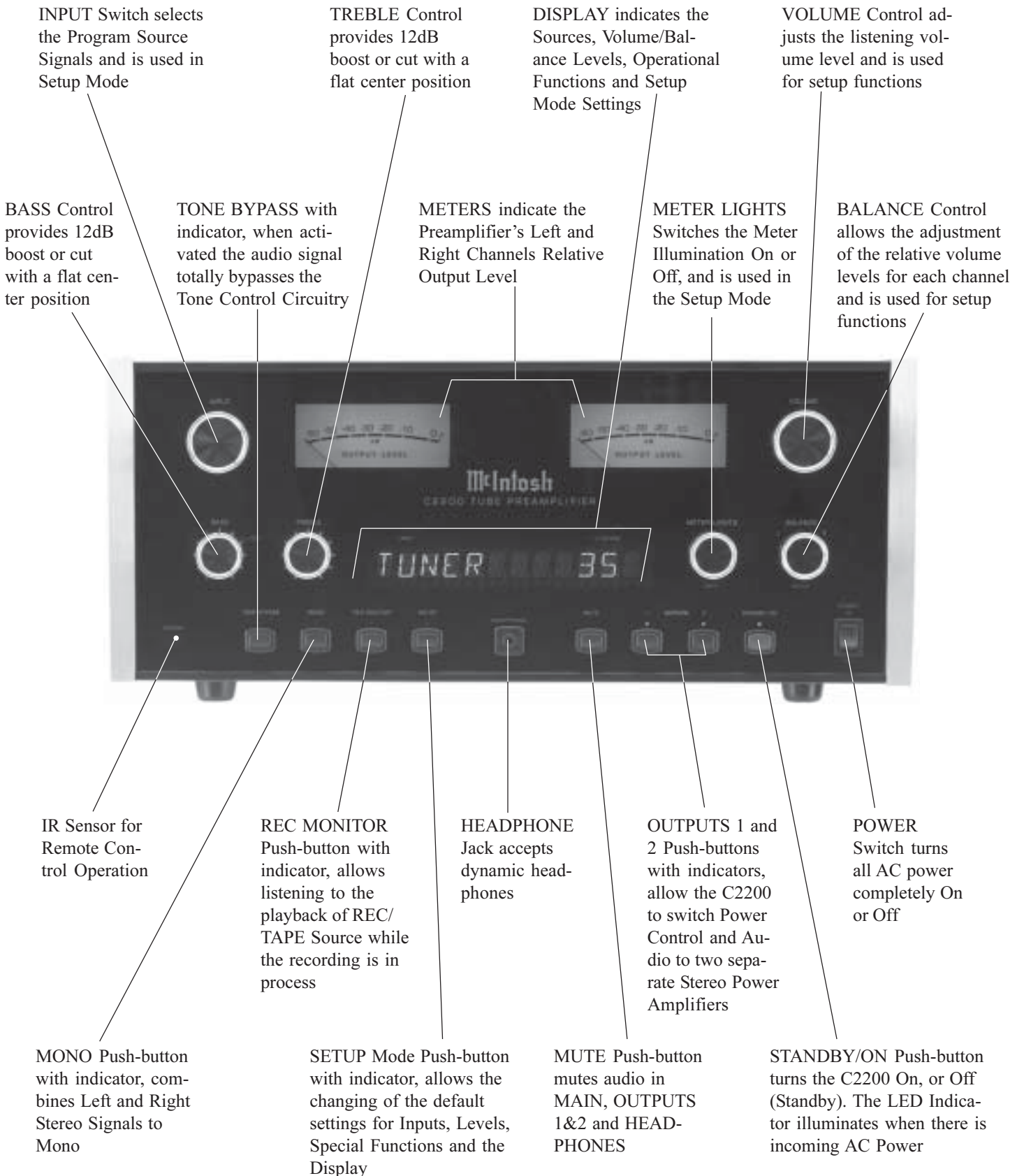

McIntosh

How to Operate the Setup Mode

Your McIntosh C2200 has been factory configured for default operating settings that will allow immediate enjoyment of superb audio without the need for further adjustments. If you wish to make changes to the factory default settings, a Setup Feature is provided to customize the operating settings using the Front Panel Alphanumeric Display.

1. Press the POWER Switch to ON, the Red LED above the STANDBY/ON Push-button lights to indicate the C2200 is in Standby mode. To switch On the C2200 press the STANDBY/ON Push-button and wait until the tube warmup period is over. Refer to figure 3.
2. Press the C2200 Front Panel SETUP Push-button. The LED above the SETUP Push-button will illuminate and the Front Panel Display will indicate DISPLAY 20. Refer to figure 1.

Note: The Front Panel Display will indicate DISPLAY 20 the first time, after then it will display whatever Setup Mode was last accessed.



Figure 1

3. Rotate the Front Panel METER LIGHTS (Menu) Control and notice that the Setup Mode advances through eight different possible adjustment selections and one informational display.
4. To exit from a specific Setup Mode, press the SETUP Push-button a second time. The LED above the SETUP Push-button will extinguish and the Front Panel Display will revert back to its normal display. Refer to figure 2.



Figure 2

Default Settings

The following listings indicate the default settings and the page number for instructions on how to change a setting.

<u>Setup Function Name</u>	<u>Setting</u>	<u>Page Number</u>
Alphanumeric Display Brightness:		
Meters Illumination On	20	14
Meters Illumination Off	5	14
Trim (Input Level)	00	14
Input Titles	-	14
Triggers	Off	16
Auto Tone	Off	16
Pass Thru (Multichannel)	Off	16
Power On	-	16
Remote (Control Type)	Norm	17
Version (C2200 Firmware)	__ . __	17

Display Brightness

The Front Panel Alphanumeric DISPLAY Brightness may be varied from a setting of 1(Dim) to 31(Bright) with two settings, one with the Meter Illumination On and the other with the Illumination Off. Follow the steps below for changing the brightness. Refer to figure 4.



Figure 4

1. Press the SETUP Push-button to access the Setup Mode.
2. Rotate the Front Panel METER LIGHTS (Menu) Control until the word DISPLAY 20 appears.
3. Rotate the BALANCE (Select) Control until the desired Display Brightness is achieved. This sets the Brightness Level with the Meters Illumination On.



Figure 3

4. Press the SETUP Push-button to exit the Setup Mode. To set the Front Panel Alphanumeric DISPLAY Brightness when the Meter Illumination is Off, perform the following steps.

5. Rotate the Front Panel METER LIGHTS (Menu) to switch Off the Meter Illumination.
6. Press the SETUP Push-button to access the Setup Mode.
7. Rotate the Front Panel METER LIGHTS (Menu) Control until the word DISPLAY 5 appears.
8. Rotate the BALANCE (Select) Control until the desired Display Brightness is achieved. This sets the Brightness Level with the Meters Illumination Off.
9. Press the SETUP Push-button to exit the Setup Mode.

Input Trim Level

Various Source Components can have slightly different volume levels. This could result in the constant need to readjust the C2200 Volume Control when switching between different Input Sources. A Volume Trim Feature on the C2200 allows the adjustment of levels for each of the Source Inputs, so that they have the same relative volume. The Tuner and CD Inputs are used in the following example.

Notes: The possible range of adjustment in volume level is $\pm 6\text{dB}$. The Tape/Record Output Levels are unaffected by any changes in the Trim Settings. Any TRIM adjustments made are retained in permanent memory and can be changed only by performing a new TRIM procedure. The Tuner Input Volume Level can serve as a reference or choose another Input Source that is frequently listened to as the reference. The reference Input Source should be set to a Trim Level of 00.

1. Rotate the INPUT Control to select the Tuner Input and adjust the VOLUME Control to the desired listening level.
2. Press the SETUP Push-button to access the Setup Mode.
3. The Front Panel Alphanumeric Display will change and the Red LED above the SETUP Push-button will be illuminated.
4. Rotate the METER LIGHTS (Menu) Control until the words TRIM 00 TUN appears. Refer to figure 5.



Figure 5

5. Rotate the INPUT Control until the words TRIM 00 CD appears. Refer to figure 6.



Figure 6

6. Rotate the VOLUME Control until the Volume Level of the CD Input is the same as the Tuner Volume Level. Refer to figure 7. Figure 7 indicates a 2.5dB decrease in the CD Level.



Figure 7

7. Rotate the INPUT Control until the next desired Input Source Name is displayed.
8. Repeat steps 5, 6 and 7 until all the Inputs with sources connected to the C2200 have the same relative volume levels when switching between them.
9. Press the SETUP Push-button to exit the Setup Mode.

Note: The Trim Level can also be set via the Remote Control. A table has been provided on page 17 to record the changes to the various inputs from the default settings.

Re-Title Inputs

The C2200 has eight Audio Inputs. These inputs already have assigned titles that will allow for immediate hookup, operation and enjoyment.

If these starting assignments do not match up with components in your system, they may be reassigned from the default settings. The following example will illustrate how to rename the AUX Input to PHONO. When the Input Selector is rotated to select what was originally the AUX Input, PHONO will now appear on the Front Panel Alphanumeric Display and Power is now supplied to the Vacuum Tubes in Phono Circuitry.

Notes: 1. Unused Inputs may be switched Off so they will not appear when rotating through the input source choices using the Input Selector and also will not be available when using the Remote Control or Keypad. Refer to figure 8.

2. The New Input Titles that are available for all the Inputs (except for the AUX Input) includes TAPE 2, LV, TV, and VCR2. The AUX Input Titles include TAPE 2, LV, TV and PHONO.



Figure 8

1. Press the SETUP Push-button to access the Setup Mode.
2. The Front Panel Alphanumeric Display will change and the Red LED above the SETUP Push-button be illuminated.
3. Rotate the METER LIGHTS (Menu) Control until the words INP AUX>AUX appears. Refer to figure 9.
Note: If another Input Title is displayed, rotate the INPUT Control to Select the AUX Input



Figure 9

4. Rotate the BALANCE (Select) Control until the Front Panel Alphanumeric Display indicates INP AUX>PH. Refer to figure 10.



Figure 10

5. Press the SETUP Push-button to exit the Setup Mode.

Power Control Triggers

Three of the C2200 Power Control Outputs are reassignable from their default settings, allowing for various functions such as activating only when a given Input is selected.

In the following example the Power Control OUTPUT 2 Jack will be reassigned to function as TRIGGER B for the PHONO Input.

1. Press the SETUP Push-button to access the Setup Mode.
2. The Front Panel Alphanumeric Display will change and the Red LED above the SETUP Push-button will be illuminated.
3. Rotate the METER LIGHTS (Menu) Control until the words TRIG OUT2 > B appears. Refer to figure 11.
Note: If another TRIG Title is displayed, rotate the INPUT Control to Select OUT2.



Figure 11

4. Rotate the BALANCE (Select) Control until the Front Panel Alphanumeric Display indicates TRIG OUT2 > - . Refer to figure 12.



Figure 12

5. Rotate the METER LIGHTS (Menu) Control until the words TRIG PHONO>- - appears. Refer to figure 13.
Note: If another Input Title is displayed, rotate the INPUT Control to Select the PHONO Input



Figure 13

6. Rotate the BALANCE (Select) Control until the Front Panel Alphanumeric Display indicates TRIG PHONO> B. Refer to figure 14.



Figure 14

7. Press the SETUP Push-button to exit the Setup Mode.

Auto Tone

The Auto Tone Feature activates the TONE BYPASS Dynamic Memory Circuit. When the Auto Tone Feature is set to the On position, the C2200 will automatically remember for each Input whenever the Tone Bypass Circuit is On or Off.

1. Press the SETUP Push-button to access the Setup Mode.
2. The Front Panel Alphanumeric Display will change and the Red LED above the SETUP Push-button will be illuminated.
3. Rotate the METER LIGHTS (Menu) Control until the words AUTOTONE OFF appears. Refer to figure 15.



Figure 15

4. Rotate the BALANCE (Select) Control until the Front Panel Alphanumeric Display indicates AUTOTONE ON. Refer to figure 16.



Figure 16

5. Press the SETUP Push-button to exit the Setup Mode.

Pass Thru Mode

The C2200 can be part of a Multichannel Sound System. The Right and Left Front Channels from a McIntosh Processor or Decoder can "Pass Thru" the C2200 and on to its associated Power Amplifier(s). The Setup Mode allows the Selection of the Input that will be used for the Right and Left Front Channels Pass Thru Mode. In the example below, the Right and Left Front Channels from the Multichannel Processor/Decoder will be connected to the AUX Input on the C2200.

1. Press the SETUP Push-button to access the Setup Mode.
2. Rotate the BALANCE Control Knob until the words PASSTHRU OFF appears. Refer to figure 17.



Figure 17

3. Rotate the INPUT Control until the Front Panel Alphanumeric Display indicates PASSTHRU AUX. Refer to figure 18.



Figure 18

4. Press the SETUP Push-button to exit the Setup Mode.

Power On Option

The Power On Option Feature permits using the Main POWER Switch instead of the STANDBY/ON Push-button for switching the C2200 Preamplifier On or Off.

Note: If the Power On Option is switched to the AUTO Mode and the Main POWER Switch is in the Off position, the Front Panel STANDBY/ON Push-button and the Remote Control POWER Push-button will be unable to switch Power On to the C2200.

1. Press the SETUP Push-button to access the Setup Mode.
2. The Red LED above the SETUP Push-button will illuminate.
3. Rotate the Front Panel METER LIGHTS (Menu) Control until the Front Panel Alphanumeric Display indicates POWERON STBY. Refer to figure 19.



Figure 19

4. Rotate the BALANCE (Select) Control until the Front Panel Alphanumeric Display indicates POWERON AUTO. Refer to figure 20.



Figure 20

Remote Control Selection

There are two choices for the Remote Control Codes the C2200 will respond to. The Remote Control included with the C2200 utilizes the NORMal McIntosh Control Codes. The Second Set of Control Codes the C2200 will respond to is referred to as the ALTERNate Codes. The ALTERNate Codes are for when the C2200 is used together with a McIntosh Multichannel Processor/Decoder in the Pass Thru Mode Hookup. This will prevent the Remote Control from affecting the operation of both units at the same time.

Note: If the ALT Remote Control Code is selected, the C2200 will not respond using the supplied McIntosh Remote Control.

1. Press the SETUP Push-button to access the Setup Mode.
2. The Front Panel Alphanumeric Display will change and the Red LED above the SETUP Push-button will be illuminated.
3. Rotate the Front Panel METER LIGHTS (Menu) Control until the words REMOTE NORM appears. Refer to figure 21.



Figure 21

4. Rotate the Front Panel BALANCE (Select) Control until the Front Panel Alphanumeric Display indicates REMOTE ALT. Refer to figure 22.



Figure 22

5. Press the SETUP Push-button to exit the Setup Mode.

Firmware Version

The C2200 functionality is controlled by internal software that is known as Firmware. The Version of the Firmware in the C2200 can be identified at any time by utilizing the Setup Mode.

1. Press the SETUP Push-button to access the Setup Mode.
2. Rotate the Front Panel METER LIGHTS (Menu) Control until the word VERSION _ . _ _ appears. Refer to figure 23.



Figure 23

3. The number after the word VERSION is the Firmware number.
4. Press the SETUP Push-button to exit the Setup Mode.

Input Source Settings			
Default Title	New Title	Trim	Trigger
AUX			
TUNER			
CD2			
CD			
DVD			
SAT			
VCR			
TAPE			

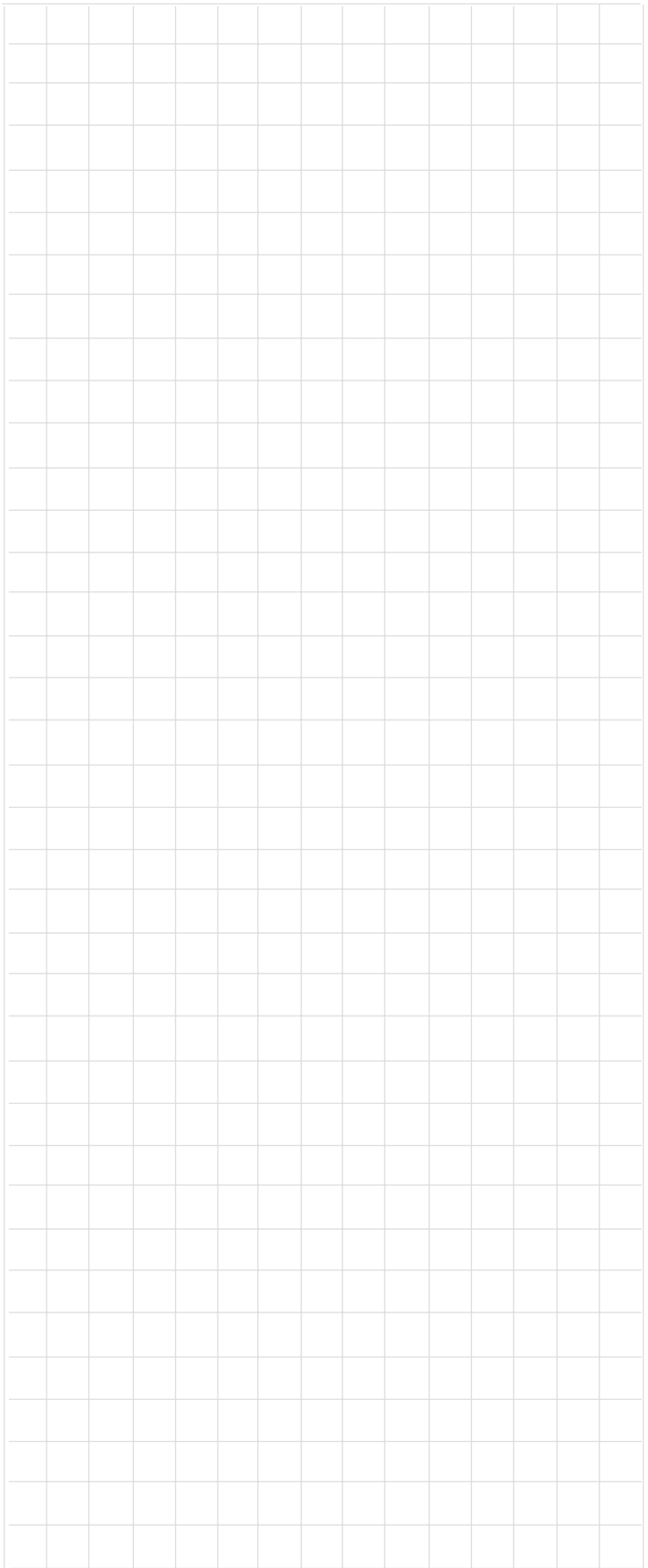

How to Operate the C2200

The McIntosh C2200 Tube Preamplifier has been factory configured for operating settings that allow immediate enjoyment of superb high fidelity audio without the need for further adjustments. If you wish to make changes to the factory default settings, refer to the SETUP Section of this Owner's Manual.

Power On and Off

Press the POWER switch to ON, the Red LED above the STANDBY/ON Push-button lights to indicate the C2200 is in Standby Mode. To Switch On the C2200 press the STANDBY/ON Push-button. The title TUBE WARMUP will appear on the Front Panel Alphanumeric Display after Turn-On, with the Audio Outputs muted. Refer to figures 24, 25 and 26.

Notes: For normal operation, switch the C2200 On and Off with the Standby/On Push-button. You may also turn On the C2200 by simply pressing the Power Push-button on the Remote Control. If the Preamplifier is not going to be used for an extended period of time, turn Off all AC Power with the Power Switch.

The amount of time the Front Panel Alphanumeric Display indicates TUBE WARMUP is dependant upon the temperature of the Tubes inside the C2200.



Figure 24

Input Source Selection

Select the desired Source with the INPUT Control or the Source Push-button on the Remote Control.

Volume Control

Adjust the VOLUME Control or the Up▲ /Down▼ Push-buttons on the Remote Control for the desired listening level.

Record Monitor

Press the REC MONITOR Push-button to hear the TAPE/REC Playback Signal during the recording process.

Tone Bypass

Press the TONE BYPASS Push-button to totally Bypass the Tone Control Circuitry, providing a flat frequency response. If the AUTOTONE circuit is set to the On position in Setup Mode, the C2200 will remember for each input whether the Tone Bypass is active.

Bass and Treble Controls

Adjust the BASS and TREBLE controls to suit your listening preferences. The Bass or Treble intensity can be increased with clockwise rotation and decreased with counterclockwise rotation.



Figure 26



Figure 25

Mono

Press the MONO Mode Push-button to combine Left and Right Stereo Signals to Mono, for the MAIN, OUTPUTS 1&2 and the HEADPHONES Jack. The MODE Push-button on the Remote Control also can be used to switch between the Stereo and Mono Modes of Operation.

Note: The TAPE/REC Outputs are not effected by the Mono Mode of Operation.

Balance Control

Adjust the BALANCE Control as needed to achieve approximately equal listening volume levels in each Loudspeaker. Rotate the BALANCE Control clockwise to emphasize the Right Channel by reducing the volume level of the Left Channel. Refer to figure 27.



Figure 27

Several seconds after the rotation of the BALANCE Control has stopped, the Front Panel Alphanumeric Display will once again indicate the Input Source and Volume together with the ">" symbol to show that the Right Channel is now louder than the Left Channel. Refer to figure 28.



Figure 28

Rotate the BALANCE Control counterclockwise to deemphasize the Right Channel until equal Balance of both Channels is achieved. Refer to figure 29.



Figure 29

Mute

Press the MUTE Push-button to Mute the Audio at the MAIN, OUTPUTS 1 & 2 and HEADPHONES Outputs. The Front Panel Alphanumeric Display will indicate the Input Source Name followed by the word MUTE in place of the actual volume setting. Refer to figure 30.



Figure 30

Setup

Pressing the SETUP Push-button activates the Setup Mode of the C2200 and allows customizing various operating functions. Refer to page 14 for additional information.

Output 1 and 2

Press OUTPUT 1 or 2 Push-buttons to send audio to separate Power Amplifiers connected to the rear panel OUTPUTS 1 or 2. It also activates the POWER CONTROL 1 & 2 Sockets on the rear panel of the C2200. Press either Push-button individually or both together.

Meter Lights

Rotate the METER LIGHTS Control counterclockwise to switch Off the Meter Illumination and rotate the control clockwise to switch On the Meter Illumination.

Note: It is normal for the brightness of the Front Panel Alphanumeric Display to dim when the Meter Illumination is switched Off. Refer to page 14 for additional information.

Pass Thru Mode

When the C2200 is connected together with a McIntosh Multichannel A/V Control Center or Surround Decoder and has the PASS THRU MODE activated, it will automatically Turn-On whenever the A/V Control Center or Surround Decoder is switched On. It will indicate on the Front Panel Alphanumeric Display "PASSTHRU". Refer to figure 31.



Figure 31

In the PASS THRU Mode, the OUTPUTS 1&2 Push-buttons remain active. The remaining C2200 Front Panel Controls and Push-buttons are deactivated as long as the C2200 is in the PASS THRU MODE.

Note: The C2200 Preamplifier remembers separately, the setting of the OUTPUTS 1&2 Push-buttons when in the Pass Thru Mode.

Reset of Microprocessors

In the event that the controls of the C2200 stop functioning, push the POWER switch OFF and wait about two minutes. Then push the POWER switch ON followed by pushing the STANDBY/ON Push-button. This will reset the C2200 microprocessors and the Preamplifier should be functioning normally.

Note: The above condition is usually caused by either interruptions in AC power and/or major changes that may occur in AC power line voltage.

Default Settings

To restore the C2200 to Factory Default Settings perform the following. Press and hold in the MONO Push-button together with the OUTPUTS 2 Push-button. Approximately 5 seconds after holding in the two the Front Panel Push-buttons together, the Front Panel Alphanumeric Display will indicate MASTER RESET. Refer to figure 32.



Figure 32

Release both Push-buttons and the Front Panel Alphanumeric Display will now indicate -- CLEARED -- and the C2200 will switch Off. Refer to figure 33.



Figure 33

Press the STANDBY/ON Push-button on the C2200 and proceed to the Setup on page 14 to re-enter and custom setting that have been previously made.

Output Meters

The C2200's Output Meters indicate the Output Voltage available at the MAIN and OUTPUT 1 & 2 Jacks to drive Power Amplifiers. Refer to figure 34. The Meters are calibrated in dBs (decibels) and respond to all the peaks contained in the musical information. They indicate to an accuracy of at least 95% of a single cycle from a 2000Hz tone burst.

The Meter Electronic Circuitry "Time Stretches" the Meter Drive Signal so the Meter Pointer pauses just long enough for the human eye to see it and is followed by a moderate decay rate.



Figure 34

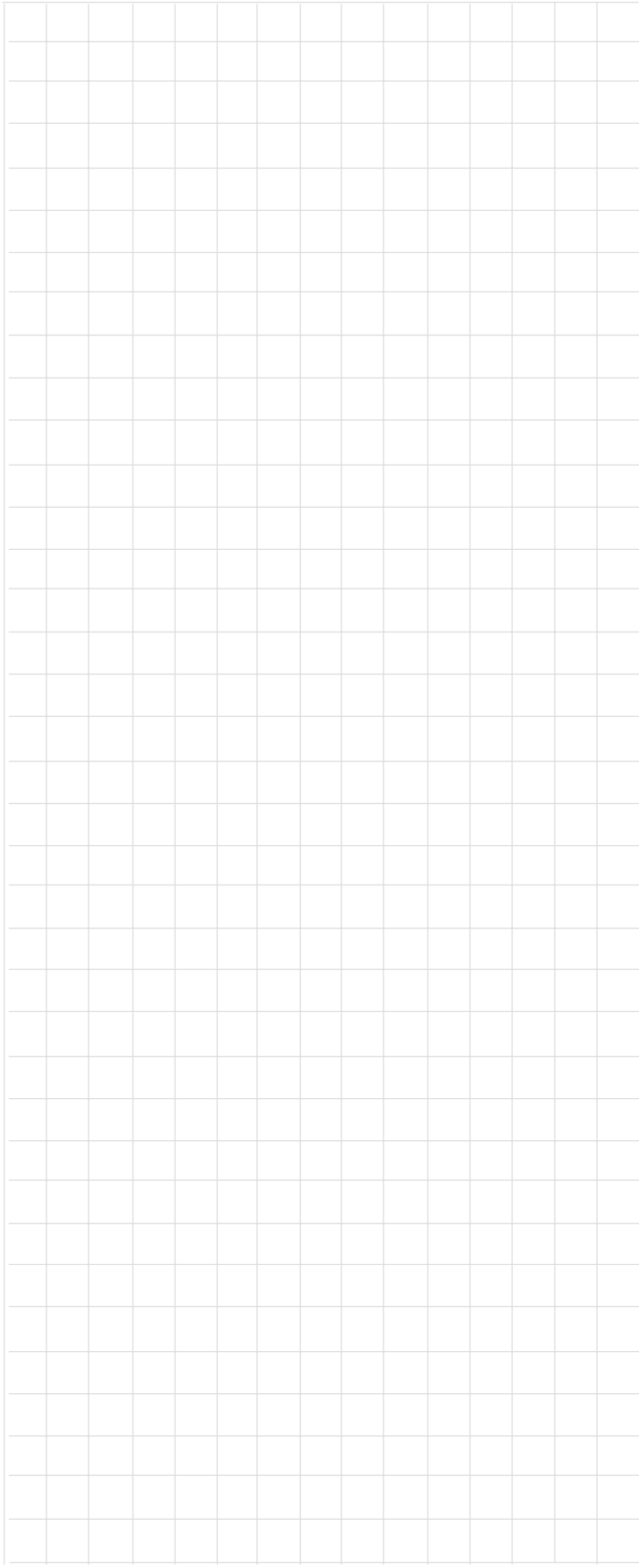

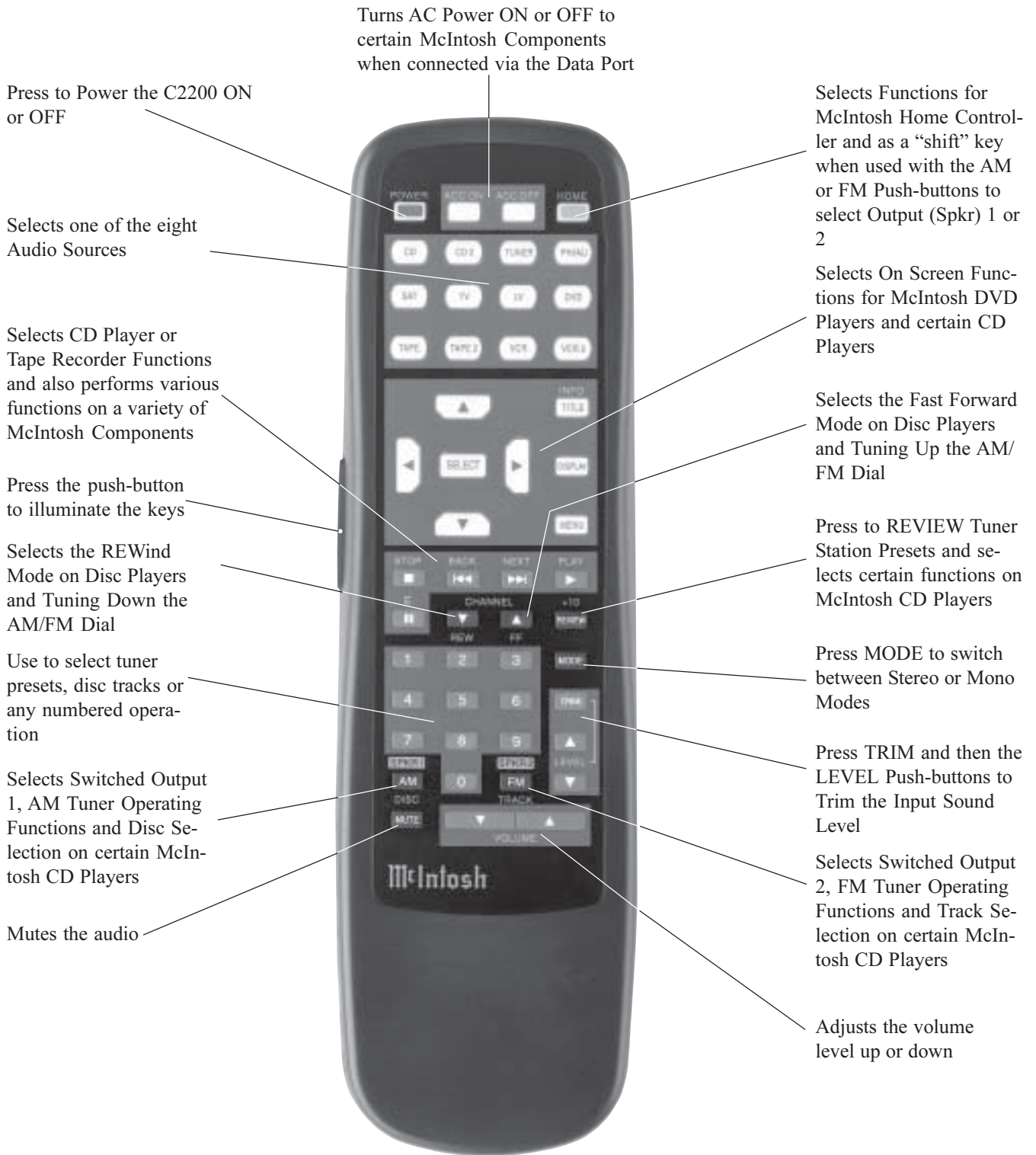

How to Operate by Remote Control

The supplied Remote Control is capable of directly controlling the functions of contemporary McIntosh Source Components connected to the C2200. Earlier McIntosh source components and other brand source components can be controlled by the C2200 with the addition of a McIntosh Remote Control Translator (RCT).

Note: Your McIntosh Dealer can assist you with the installation and operation of the Remote Control Translator (RCT).

Mute

Press the MUTE Push-button to mute audio at all the Preamplifier Outputs, except the TAPE OUTPUTS. Press MUTE a second time to unmute audio.

Mono

Press the MODE Push-button to combine Left and Right Stereo Signals to Mono at all the Preamplifier Outputs, except the Tape Outputs.

Trim and Level

Press the TRIM Push-button to activate the Input TRIM Function. Press the LEVEL Up▲ and Down▼ Push-buttons to Trim the Input Sound Level. For additional information refer to page 15.

Input Source Selection

Press any of the eight Input Push-buttons to select a program source.

CD/Tape Functions

Use these push-buttons to operate a CD Player, CD Changer or Tape Recorder.

Numbered Push-buttons

Press Push-buttons 0 through 9 to access tuner station presets or CD tracks/discs.

Disc and Track

Use the DISC and TRACK Push-buttons when a CD player or changer is being used.

Tuner Push-buttons

Press the AM or FM Push-button to select the desired broadcast band. Press and release the Channel Up▲ or Down▼ Push-button to move from station to station. Press and hold a Channel Up▲ or Down▼ Push-button to move continuously from station to station. Press REVIEW to start the automatic brief audition of each of the presets stored in the tuner memory. Press REVIEW a second time to stop on a station preset and exit the Review process.

Volume

Press the Up▲ or Down▼ VOLUME Push-button to raise or lower the listening volume level.

Note: The TAPE OUTPUTS are not affected by volume changes.

Amplifier Selection

Press HOME Push-button followed by the SPEAKER 1 or 2 Push-buttons either separately or together, to control the Rear Panel OUTPUTS 1, 2 Jacks.

Acc On/Acc Off

Press ACC ON to turn the power ON to a McIntosh Disc Player. Press ACC OFF to turn the power OFF to a McIntosh Disc Player.

E

Press E to perform various functions on a variety of McIntosh Components. It will also pause the playing of a Disc or Tape Player.

Lighting

Press and release the LIGHTING Push-button to momentarily illuminate the upper half of the Remote Control Push-buttons.

Note: While the LIGHTING Push-button is being depressed the Remote Control will be unable to send a remote command. When the LIGHTING Push-button is released the push-buttons will continue to stay illuminated for approximately three seconds thus allowing you to send the desired command.

Optional Remote Control

If the C2200 is used in the Pass Thru Mode, an optional McIntosh Remote Control Model UR12 allows use of an Alternate Set of Remote Control Codes. This will prevent the C2200 from responding to the McIntosh A/V Control Center or Surround Decoder Remote Control. See your McIntosh Dealer for additional information.



Technical Description

McIntosh Laboratory, the company who introduced the world's first amplifier that could be called "High Fidelity", has done it again. The McIntosh engineering staff has created a Tube Preamplifier without compromise, using the most advanced McIntosh circuit design concepts. Creating a Preamplifier with this level of performance did not come easily. Many months of design, testing and measuring were required. Extensive controlled listening tests, the ultimate form of measuring, were made before the final design was accepted.

Input and Output Switching

All signal switching in the C2200 is done by Electro-Magnetic devices. Electro-Magnetic Switching is a proven technology that uses the latest in materials and manufacturing methods. Each switch consists of a glass tube that is filled with an inert oxygen-free atmosphere and sealed with tiny leads protruding from either end. These leads extend into the tube and overlap one another with a separation of a few thousandths of an inch. The leads are made from a ferrous material that is influenced by a magnetic field. They are first plated with gold as a base material, then with rhodium and finally ruthenium. Ruthenium is the best contact material known.

The glass assembly is then placed in the center of a multilayer coil of copper wire. The entire assembly is molded together in a tough shock absorbing material. The switch and coil connectors extend from the bottom in the form of printed circuit board terminals. When a DC voltage is applied to the coil, current flows and creates a magnetic field. The force of the field causes the leads to bend and contact one another inside the sealed glass tube. The inert gas eliminates corrosion of the contacts and insures a low resistance, distortion free switch.

All inputs, outputs, and data ports are controlled by logic circuits in the C2200. The logic is changed by Front Panel Push-buttons or by a microprocessor IR decoder. This microprocessor IR decoder is programmed with exclusive McIntosh software. It receives data from the Front Panel or Keypad/Sensors and provides the command signals for input switching, data switching, and volume control.

Phono Circuitry

The PHONO amplifier uses 12AX7 tubes. Its input stage has been optimized for low noise and low distortion performance. Open loop gain of this circuit is 10,000. With high open loop gain, a large amount of negative feedback can be used around the phono amplifier to further reduce noise and

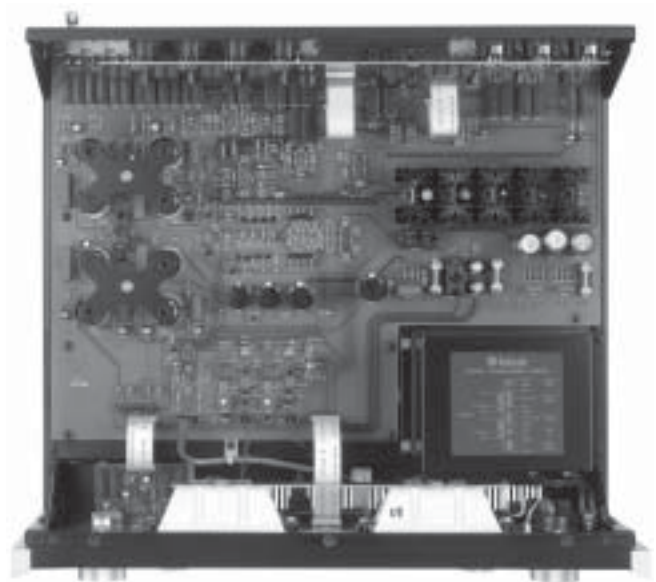

Top Inside View of the C2200

distortion. The feedback network also provides precision RIAA frequency compensation.

Input sensitivity of the phono amplifier is 4.4 millivolts. The gain of the amplifier is 40dB at 1000Hz. The phono amplifier has a very wide dynamic range. At 1000Hz, the phono input circuit will accept 50 millivolts without overload, a voltage far greater than the output of any current magnetic phono cartridge. Therefore, phono input overload is virtually impossible. A signal level of 10 millivolts at the phono input at 1000Hz will produce 1 volt at the TAPE output. This output has a source impedance of 500 ohms unbalanced.

Tone Control Circuitry

The TONE control section uses 12AX7 amplifiers. The amplifier stages have been optimized for low noise and minimum distortion. Other electrical circuits are arranged in a configuration that is the equivalent of a series tuned circuit. A control potentiometer inserts this series tuned circuit into either the feedback or input section of the tone amplifier. This provides a 12dB boost or cut at the frequency of the tuned circuit. The overall gain of the stage is 0dB when the potentiometer is at its center detent position. A TONE BY-PASS Switch is provided to remove all tone control circuits from the signal path.

Volume Control Circuitry

The VOLUME Control for the C2200 is a very special "Hi Tech" circuit. It employs a Microprocessor Controlled

Logarithmic Attenuator. There are stringent requirements for the Volume Attenuator in this design. The channel to channel tracking accuracy must be maintained. After a great deal of research we found that mechanical potentiometers cannot approach the tracking accuracy that McIntosh felt was necessary. Therefore, we choose to use a dual attenuator with switching driven from a 16-bit serial data word. Resistor values are decoded by an internal multiplexer to steps of 0.5dB. Total attenuator range is 107dB. Step error and channel matching is less than .1dB. THD+N is typically less than .001% and dynamic range is 120dB. A second stage is added to the volume attenuator. It controls the gain of the output amplifier. Its steps are interlaced with the main section in such a manner that it reduces the output amplifier gain to unity almost immediately as volume is reduced. Therefore, noise and distortion generated in earlier stages is not amplified and low level S/N is dramatically improved. It is comparable to having a straight wire between the input switching and output connector. Care has been taken to insure that there are no audible artifacts in the analog output signal during volume control changes. There is a zero

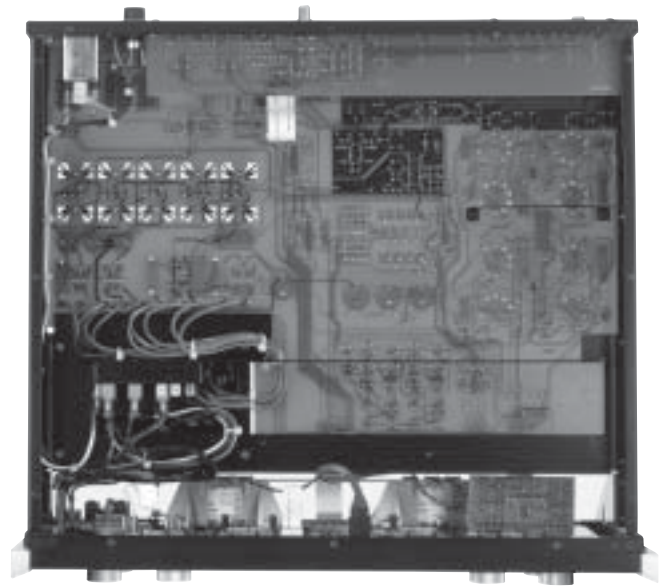

Bottom Inside View of the C2200

crossing detector built in and all changes in level occur at the signal zero crossing.

Overall Design

The C2200 was designed to use the best components available. All resistors are the lowest noise 1% metal film. Each amplifier section has its own power supply filter. The C2200 is truly worthy of being considered a companion and peer of the world famous MC2000 and MC2102 Tube Power Amplifiers.

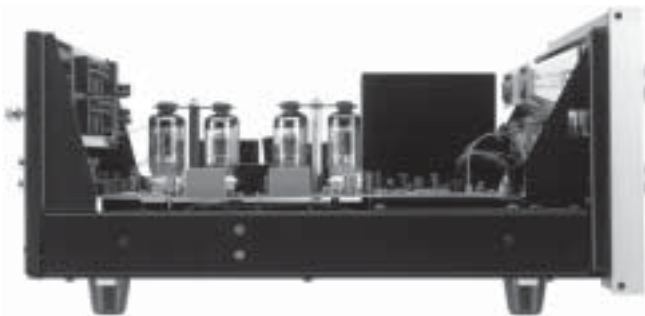

Side Inside View of the C2200

Block Diagram of Preamplifier and Meter Circuitry (one channel shown) with Power Supply

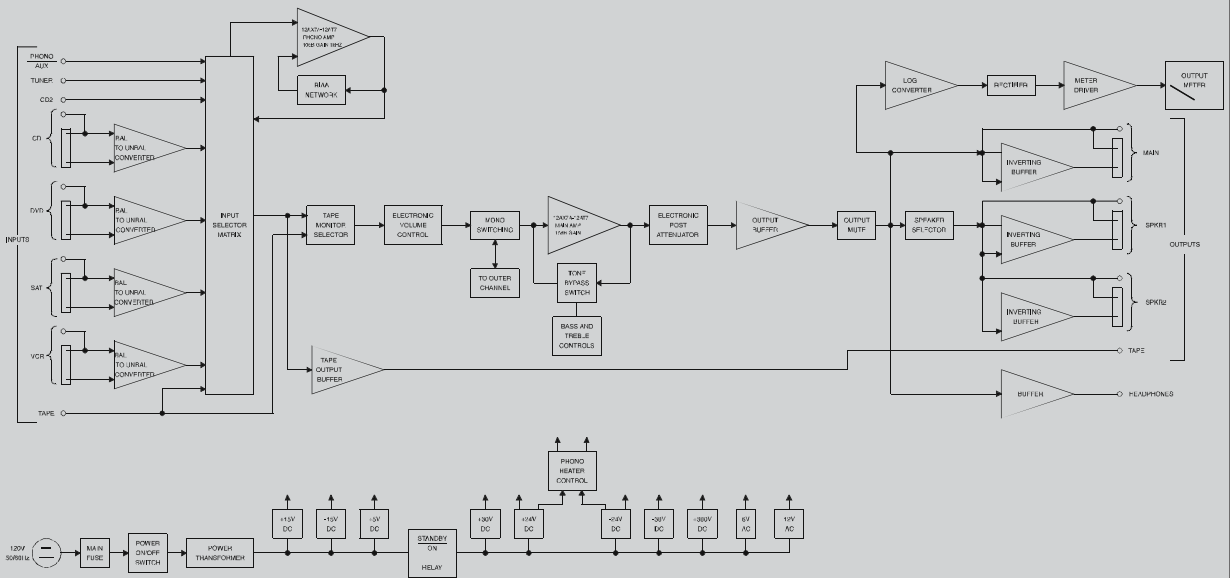

Specifications

Frequency Response

+0, -0.5dB from 20Hz to 20,000Hz

Total Harmonic Distortion

0.08% from 20Hz to 20,000Hz

Signal To Noise Ratio

Phono, 80dB

High Level, 93dB

Maximum Voltage Output

8Vrms Unbalanced, 16Vrms Balanced

Output Impedance

250 ohms Unbalanced, 500 ohms Balanced

Sensitivity

Phono MM, 4.4mV for 2.5V rated output

High Level, 450mV for 2.5V rated output

Input Impedance

Phono MM, 47K ohms, 65pF

High Level, 22K Unbalanced, 44K Balanced

Maximum Input Signal

Phono MM, 50mV @ 1,000Hz

High Level, 5V Unbalanced, 10V Balanced

Power Requirements

100 Volts, 50/60Hz at 75 watts

110 Volts, 50/60Hz at 75 watts

120 Volts, 50/60Hz at 75 watts

220 Volts, 50/60Hz at 75 watts

230 Volts, 50/60Hz at 75 watts

240 Volts, 50/60Hz at 75 watts

Note: Refer to the rear panel of the C2200 for the correct voltage.

Tube Compliment

Phono Circuitry:

2 - 12AX7A

2 - 12AT7A

High Level Circuitry:

2 - 12AX7A

2 - 12AT7A

Overall Dimensions

17-1/2 inches (44.5cm) W, 7-5/8 inches (19.37cm) H, 20 inches (50.8cm) D (including clearance for connectors)

Weight

26.75 pounds (12.14 kg) net, 47.75 pounds (21.67 kg) in shipping carton

Packing Instructions

In the event it is necessary to repack the equipment for shipment, the equipment must be packed exactly as shown below. It is very important that the four plastic feet are attached to the bottom of the equipment. This will ensure the proper equipment location on the bottom pad. Failure to do this will result in shipping damage.

Use the original shipping carton and interior parts only if they are all in good serviceable condition. If a shipping carton or any of the interior part(s) are needed, please call or write Customer Service Department of McIntosh Laboratory. Please see the Part List for the correct part numbers.

Quantity	Part Number	Description
1	033888	Shipping carton only
4	033887	End cap
1	033697	Inside carton only
1	033725	Top pad
1	034194	Bottom pad
1	034037	Inner carton pad
4	017218	Plastic foot
4	100159	#10-32 x 3/4" screw
4	104083	#10-7/16" Flat washer

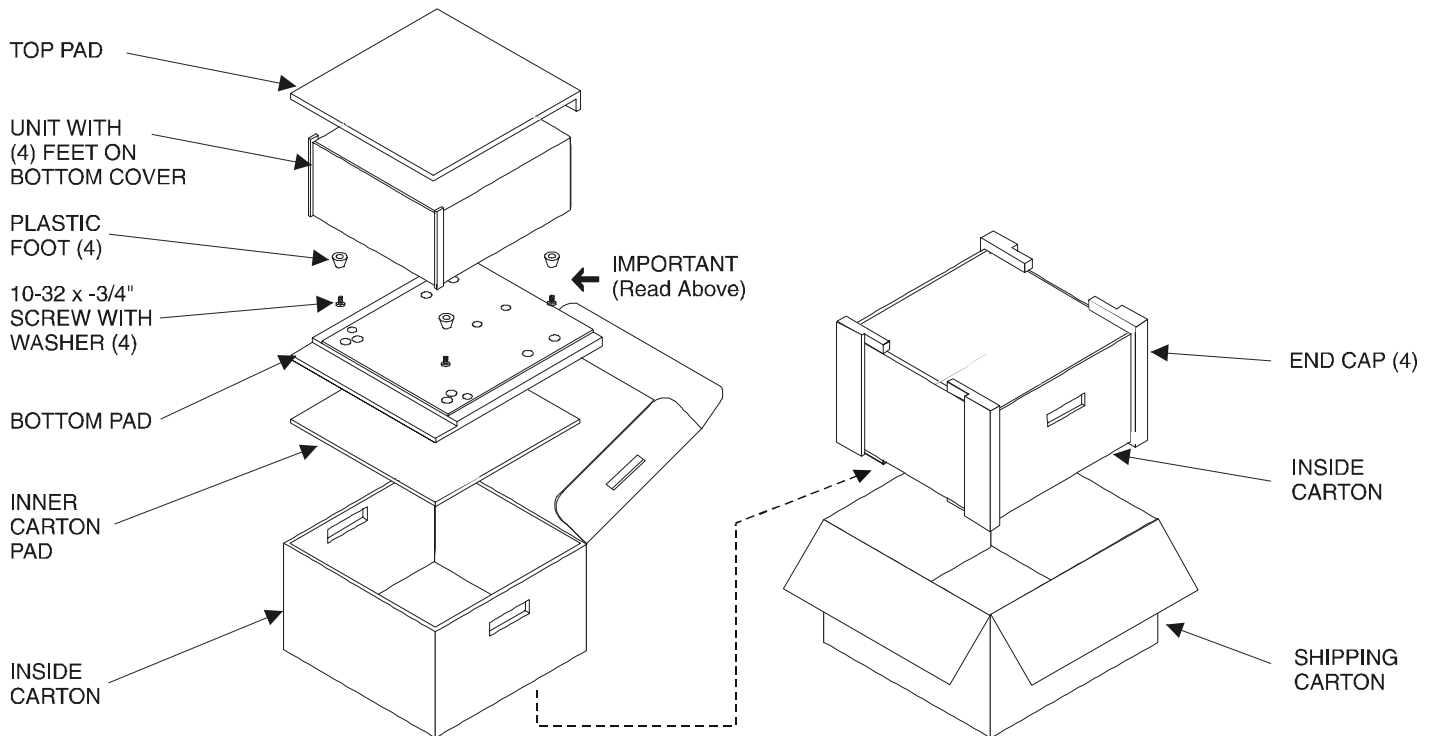

McIntosh[®]

McIntosh Laboratory, Inc.
2 Chambers Street
Binghamton, NY 13903